

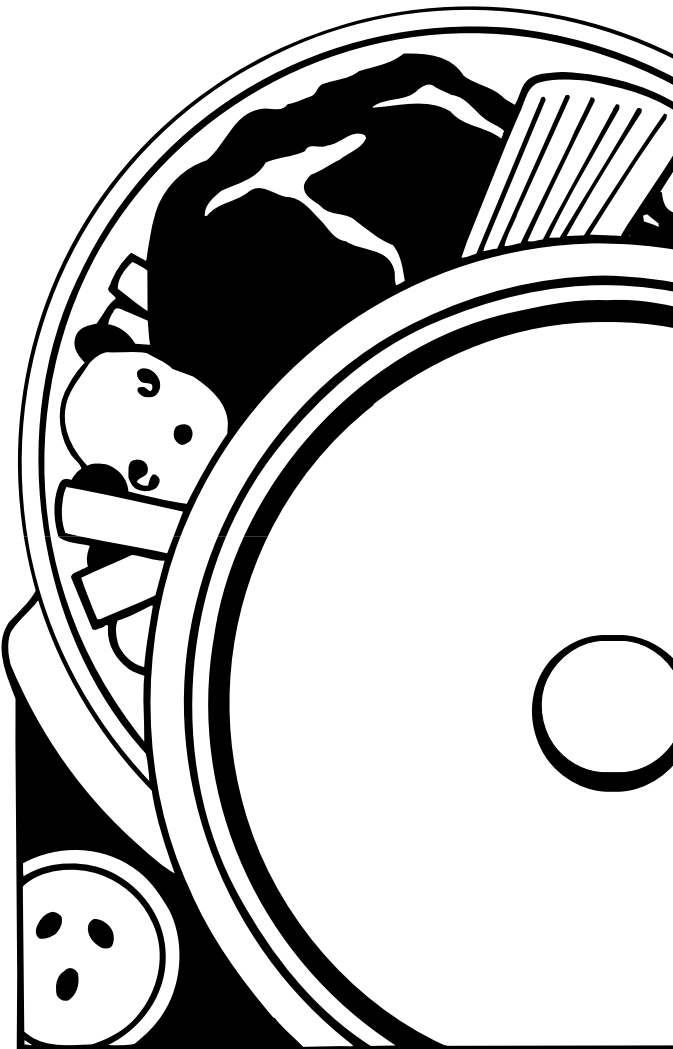

# Use And Care

G U I D E



<b>A Note to You</b> .....	2
<b>Microwave Oven Safety</b> .....	3
<b>Installation Instructions</b> .....	5
<b>Getting to Know Your Microwave Oven</b> .....	7
<b>Using Your Microwave Oven</b> ....	13
Cooking at high cook power .....	13
Cooking at different cook powers .....	14
Cooking with more than one cook cycle .....	15
Using ADD MINUTE .....	16
Using REHEAT .....	17
Reheating tips .....	17
Using DEFROST .....	18
Defrosting Tips .....	18
Using POPCORN .....	19
Using BREAKFAST .....	19
Using VEGETABLES .....	20
Using BAKED POTATOES .....	21
Using BEVERAGE .....	21
Using FROZEN ENTREE .....	22
<b>Caring for Your Microwave Oven</b> .....	22
<b>Cooking Guide</b> .....	23
<b>Questions and Answers</b> .....	25
<b>Troubleshooting</b> .....	26
<b>Requesting Assistance or Service</b> .....	27
<b>Warranty</b> .....	28

CONSERVATOR MICROWAVE OVEN

# A Note to You

## Thank you for buying a CROSLEY® appliance.

To ensure that you enjoy years of trouble-free operation, we developed this Use and Care Guide. It contains valuable information about how to operate and maintain your microwave oven properly and safely. Please read it carefully.

Also, please complete and mail in the Ownership Registration Card provided with your appliance. The card helps us notify you about any new information on your appliance.

## Please record your model's information.

Whenever you call to request service for your appliance, you need to know your complete model number and serial number. You can find this information on the model and serial number plate (see diagram in the "Microwave oven features section" for location of plate).

Please also record the purchase date of your appliance and your dealer's name, address, and telephone number.

**Model Number** \_\_\_\_\_

**Serial Number** \_\_\_\_\_

**Purchase Date** \_\_\_\_\_

**Dealer Name** \_\_\_\_\_

**Dealer Address** \_\_\_\_\_

**Dealer Phone** \_\_\_\_\_

**Keep this book and the sales slip together in a safe place for future reference. It is important for you to save your sales receipt showing the date of purchase. Proof of purchase will assure you of in-warranty service.**

# Microwave Oven Safety

Your safety and the safety of others is very important.

We have provided many important safety messages in this manual and on your appliance. Always read and obey all safety messages.



This is the safety alert symbol.

This symbol alerts you to hazards that can kill or hurt you and others.

All safety messages will be preceded by the safety alert symbol and the word "DANGER" or "WARNING." These words mean:

**⚠ DANGER**

You will be killed or seriously injured if you don't follow instructions.

**⚠ WARNING**

You can be killed or seriously injured if you don't follow instructions.

All safety messages will identify the hazard, tell you how to reduce the chance of injury, and tell you what can happen if the instructions are not followed.

## IMPORTANT SAFETY INSTRUCTIONS

When using electrical appliances basic safety precautions should be followed, including the following:

**WARNING:** To reduce the risk of burns, electric shock, fire, injury to persons, or exposure to excessive microwave energy:

- Read all instructions before using the microwave oven.
- Read and follow the specific "PRECAUTIONS TO AVOID POSSIBLE EXPOSURE TO EXCESSIVE MICROWAVE ENERGY" found in this section.
- The microwave oven must be grounded. Connect only to properly grounded outlet. See "GROUNDING INSTRUCTIONS" found in the "Installation Instructions" section.
- Install or locate the microwave oven only in accordance with the provided Installation Instructions.
- Some products such as whole eggs in the shell and sealed containers – for example, closed glass jars – may explode and should not be heated in the microwave oven.
- Use the microwave oven only for its intended use as described in this manual. Do not use corrosive chemicals or vapors in the microwave oven. This type of oven is specifically designed to heat, cook, or dry food. It is not designed for industrial or laboratory use.
- As with any appliance, close supervision is necessary when used by children.
- Do not operate the microwave oven if it has a damaged cord or plug, if it is not working properly, or if it has been damaged or dropped.

**– SAVE THESE INSTRUCTIONS –**

## IMPORTANT SAFETY INSTRUCTIONS

- The microwave oven should be serviced only by qualified service personnel. Call an authorized service company for examination, repair, or adjustment.
- Do not cover or block any openings on the microwave oven.
- Do not store the microwave oven outdoors. Do not use the microwave oven near water – for example, near a kitchen sink, in a wet basement, or near a swimming pool, and the like.
- Do not immerse cord or plug in water.
- Keep cord away from heated surfaces.
- Do not let cord hang over edge of table or counter.
- See door surface cleaning instructions in the “Caring for Your Microwave Oven” section.
- To reduce the risk of fire in the oven cavity:
  - Do not overcook food. Carefully attend the microwave oven if paper, plastic, or other combustible materials are placed inside the oven to facilitate cooking.
  - Remove wire twist-ties from paper or plastic bags before placing bag in oven.
  - If materials inside the oven should ignite, keep oven door closed, turn oven off, and disconnect the power cord, or shut off power at the fuse or circuit breaker panel.
  - Do not use the cavity for storage purposes. Do not leave paper products, cooking utensils, or food in the cavity when not in use.
  - Do not mount over a sink.
  - Do not store anything directly on top of the microwave oven when the microwave oven is in operation.

**– SAVE THESE INSTRUCTIONS –**

## PRECAUTIONS TO AVOID POSSIBLE EXPOSURE TO EXCESSIVE MICROWAVE ENERGY...

- (a) Do not attempt to operate this oven with the door open since open-door operation can result in harmful exposure to microwave energy. It is important not to defeat or tamper with the safety interlocks.
- (b) Do not place any object between the oven front face and the door or allow soil or cleaner residue to accumulate on sealing surfaces.
- (c) Do not operate the oven if it is damaged. It is particularly important that the oven door close properly and that there is no damage to the:
  - (1) Door (bent),
  - (2) Hinges and latches (broken or loosened),
  - (3) Door seals and sealing surfaces.
- (d) The oven should not be adjusted or repaired by anyone except properly qualified service personnel.

# Installation Instructions

Before you begin operating the oven, carefully read the following instructions.

- 1. Empty** the microwave oven and **clean** inside it with a soft, damp cloth. **Check** for damage such as a door that isn't lined up correctly, damage around the door, or dents inside the oven or on the exterior. If there is any damage, do not operate the oven until an authorized Whirlpool service technician has checked it and made any needed repairs.
- 2. Put** the oven on a cart, counter, table, or shelf that is strong enough to hold the oven and the food and utensils you put in it. **(The control side of the unit is the heavy side. Use care when handling the oven.)** The weight of the oven is about 40 lbs (18kg). The microwave oven should be at a temperature above 50°F (10°C) for proper operation.

**NOTE:** You can fasten your microwave oven under a cabinet by using the proper trim kit. See "Microwave oven features" in the "Getting to Know" section.

**NOTE:** Do not block the exhaust vents or rear air intake openings. Allow a few inches of space at the back of the oven where the intake openings are located. Blocking the air intake openings and exhaust vents could cause damage to the oven and poor cooking results. Make sure the microwave oven legs are in place to ensure proper airflow. If vents are blocked, a sensitive thermal safety device automatically turns the oven off. The oven will not work until it has cooled enough.

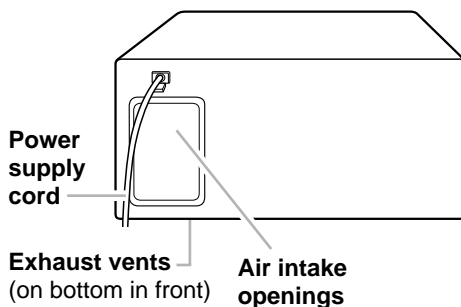

## Electrical requirements

Observe all governing codes and ordinances. A 120 Volt, 60 Hz, AC only, 15 amp fused electrical supply is required. (A time-delay fuse is recommended.) It is recommended that a separate circuit serving only this appliance be provided.

### **⚠ WARNING**



#### **Fire Hazard**

**Do not install the oven next to or over a heat source without a UL or CSA approved trim kit.**

**Doing so can result in death, fire, or electrical shock.**

### **⚠ WARNING**



#### **Electrical Shock Hazard**

**Plug into a grounded 3 prong outlet.**

**Do not remove ground prong.**

**Do not use an adapter.**

**Do not use an extension cord.**

**Failure to follow these instructions can result in death, fire, or electrical shock.**

## GROUNDING INSTRUCTIONS

For all cord connected appliances:  
The microwave oven must be grounded. In the event of an electrical short circuit, grounding reduces the risk of electric shock by providing an escape wire for the electric current. The microwave oven is equipped with a cord having a grounding wire with a grounding plug. The plug must be plugged into an outlet that is properly installed and grounded.

**WARNING:** Improper use of the grounding can result in a risk of electric shock.

Consult a qualified electrician or serviceman if the grounding instructions are not

completely understood, or if doubt exists as to whether the microwave oven is properly grounded.

Do not use an extension cord. If the power supply cord is too short, have a qualified electrician or serviceman install an outlet near the microwave oven.

For a permanently connected appliance: This appliance must be connected to a grounded, metallic, permanent wiring system, or an equipment grounding conductor should be run with the circuit conductors and connected to the equipment grounding terminal or lead on the appliance.

# Getting to Know Your Microwave Oven

This section discusses the concepts behind microwave cooking. It also shows you the basics you need to know to operate your microwave oven. Please read this information before you use your oven.



## ⚠️ WARNING

### Explosion Hazard

**Do not store flammable materials such as gasoline near the microwave oven.**

**Doing so can result in death, explosion, or fire.**

## How your microwave oven works

**Microwave ovens are safe.** Microwave energy is not hot. It causes food to make its own heat, and it's this heat that cooks the food.

Microwaves are like TV waves, radio-waves, or light waves. You cannot see them, but you can see what they do.

**A magnetron** in the microwave oven produces microwaves. The microwaves move into the oven where they contact food as it turns on the turntable.

**The glass turntable** of your microwave oven lets microwaves pass through. Then they bounce off a metal floor, back through the glass turntable, and are absorbed by the food.

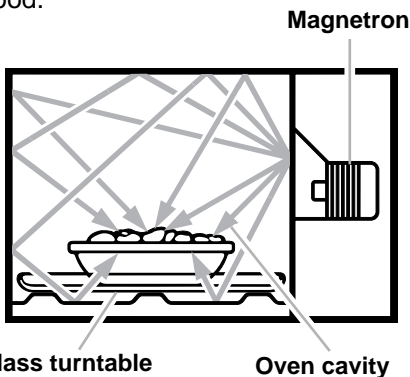

**Microwaves** pass through most glass, paper, and plastics without heating them so food absorbs the energy. Microwaves bounce off metal containers so food does not absorb the energy.

## Radio interference

Using your microwave oven may cause interference to your radio, TV, or similar equipment. When there is interference, you can reduce it or remove it by:

- **Cleaning** the door and sealing surfaces of the oven.
- **Adjusting** the receiving antenna of the radio or television.
- **Moving** the radio/TV away from the microwave oven.
- **Plugging** the microwave oven into a different outlet so that the microwave oven and radio/TV are on different branch circuits.

## For the best cooking results

- **Always cook food** for the shortest cooking time recommended. Check to see how the food is cooking. If needed, touch the ADD MINUTE pad while the oven is operating or after the cooking cycle is over (see the "Using ADD MINUTE" section).
- **Stir, turn over, or rearrange** the food being cooked about halfway through the cooking time for all recipes. This will help make sure the food is evenly cooked.
- **If you do not have a cover** for a dish, use wax paper, or microwave-approved paper towels or plastic wrap. Remember to turn back a corner of the plastic wrap to vent steam during cooking.

---

## Testing your microwave oven

To test the oven put about 1 cup (250 ml) of cold water in a glass container in the oven. Close the door. Make sure it latches. Cook at 100% power for 2 minutes. When the time is up, the water should be heated.

---

## Testing your dinnerware or cookware

### Test dinnerware or cookware before using.

To test a dish for safe use, put it into the oven with a cup of water beside it. Cook at 100% cook power for one minute. **If the dish gets hot and water stays cool, do not use it.**

Some dishes (melamine, some ceramic dinnerware, etc.) absorb microwave energy, becoming too hot to handle and slowing cooking times. Cooking in metal containers not designed for microwave use could damage the oven, as could containers with hidden metal (twist-ties, foil lining, staples, metallic glaze or trim).

---

## Operating safety precautions

- **Do not** operate the microwave oven unless the glass turntable is securely in place and can rotate freely. The turntable can rotate in either direction. **Make sure** the turntable is correct-side up in the oven. **Handle your turntable with care** when removing it from the oven to avoid possibly breaking it. If your turntable cracks or breaks, contact your dealer for a replacement.
- **When you use a browning dish**, the browning dish bottom must be at least  $\frac{3}{16}$  inch (5mm) above the turntable. Follow the directions supplied with the browning dish.
- **Never cook or reheat a whole egg inside the shell.** Steam buildup in whole eggs may cause them to burst and burn you, and possibly damage the oven. **Slice** hard-boiled eggs before heating. In rare cases, poached eggs have been known to explode. **Cover** poached eggs and **allow** a standing time of one minute before cutting into them.
- **For best results, stir any liquid several times before heating or reheating.** Liquids heated in certain containers (especially containers shaped like cylinders) may become overheated. The liquid may splash out with a loud noise during or after heating or when adding ingredients (coffee granules, tea bags, etc.). This can harm the oven and possibly injure someone.
- **Microwaves** may not reach the center of a roast. The heat spreads to the center from the outer, cooked areas just as in regular oven cooking. This is one of the reasons for letting some foods (for example, roasts or baked potatoes) stand for a while after cooking, or for stirring some foods during the cooking time.
- **Do not deep fry** in the oven. Microwavable cookware is not suitable and it is difficult to maintain appropriate deep frying temperatures.
- **Do not overcook potatoes.** Fire could result. At the end of the recommended cooking time, potatoes should be slightly firm because they will continue cooking during standing time. **After microwaving, wrap** potatoes in foil and **set aside** for 5 minutes. They will finish cooking while standing.
- **Never** lean on the door or allow a child to swing on it when the door is open. Injury could result.
- **Use hot pads.** Microwave energy does not heat containers, but heat from the food can make the container hot.
- **Do not** use newspaper or other printed paper in the oven. Fire could result.
- **Do not** dry flowers, fruit, herbs, wood, paper, gourds, or clothes in the oven. Fire could result.
- **Do not** start a microwave oven when it is empty. Product life may be shortened. If you practice programming the oven, put a container of water in the oven. It is normal for the oven door to look wavy after the oven has been running for a while.
- **Do not** try to melt paraffin wax in the oven. Paraffin wax will not melt in a microwave oven because it allows microwaves to pass through it.



## Microwave oven features

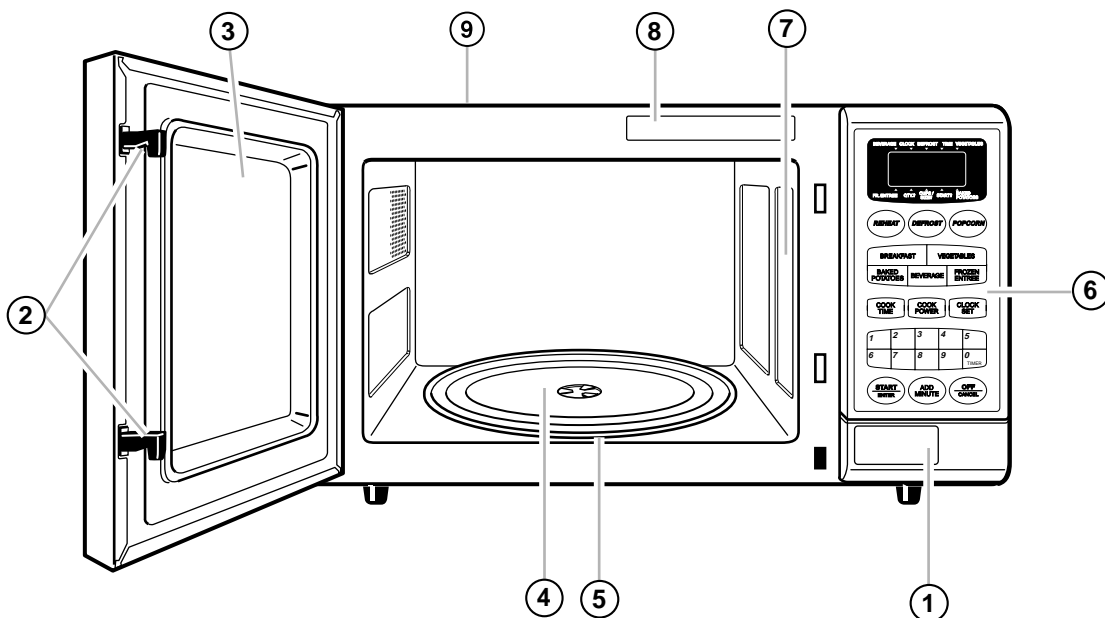

Your microwave oven is designed to make your cooking experience as enjoyable and productive as possible. To get you up and running quickly, the following is a list of the oven's basic features:

1. **One-Touch Door Open Button.** Push to open door.
2. **Door Safety Lock System.** The oven will not operate unless the door is securely closed.
3. **Window with Metal Shield.** Shield prevents microwaves from escaping. It is designed as a screen to allow you to view food as it cooks.
4. **Glass Turntable.** This turntable turns food as it cooks for more even cooking. It must be in the oven during operation for best cooking results.
5. **Turntable Support** (under turntable).
6. **Control Panel.** Touch pads on this panel to perform all functions.

7. **Light.** Automatically turns on when door is opened or when oven is operating.

8. **Cooking Guide Label.**

9. **Model and Serial Number Plate** (on back).

### Under-the-counter kit

You can fasten your microwave oven under a cabinet by using the following kit:

Kit No. 4396041Q (white) 4396042B (black)

Use the order card included with your Use and Care Guide.

**NOTE:** Some models have the under-the-counter kit and installation instructions already included with your microwave.

## Control panel features

Your microwave oven control panel lets you select a desired cooking function quickly and easily. The following is a list of all the Command and Number pads located on the control panel.

**For more information on these features, see “Using your microwave oven” section.**

1. **Display.** The display includes a clock and indicators to tell you time of day, cooking time settings, and cooking functions.
2. **REHEAT.** Touch this pad 1-4 times to reheat food from one of four preset categories.
3. **DEFROST.** Touch this pad followed by Number pads to thaw frozen food.
4. **POPCORN.** Touch this pad to pop a “snack size” (1.75 oz [50g]) bag of popcorn.
5. **BREAKFAST.** Touch this pad 1-3 times to cook breakfast foods from one of three preset categories.
6. **VEGETABLES.** Touch this pad 1-2 times to cook vegetables from one of two preset categories.
7. **BAKED POTATOES.** Touch this pad followed by Number pads to bake 1 to 2 potatoes.
8. **BEVERAGE.** Touch this pad to **reheat** a beverage. The oven will automatically heat for a preset time and cook power.
9. **FROZEN ENTREE.** Touch this pad to heat a frozen entree. The oven will automatically heat for a preset time and cook power.
10. **COOK TIME.** Touch this pad followed by Number pads to enter cooking times.
11. **COOK POWER.** Touch this pad, after the cook time has been set, followed by a Number pad to set the amount of microwave energy released to cook the food. The higher the number, the higher the power wattage and faster the “cooking speed.”

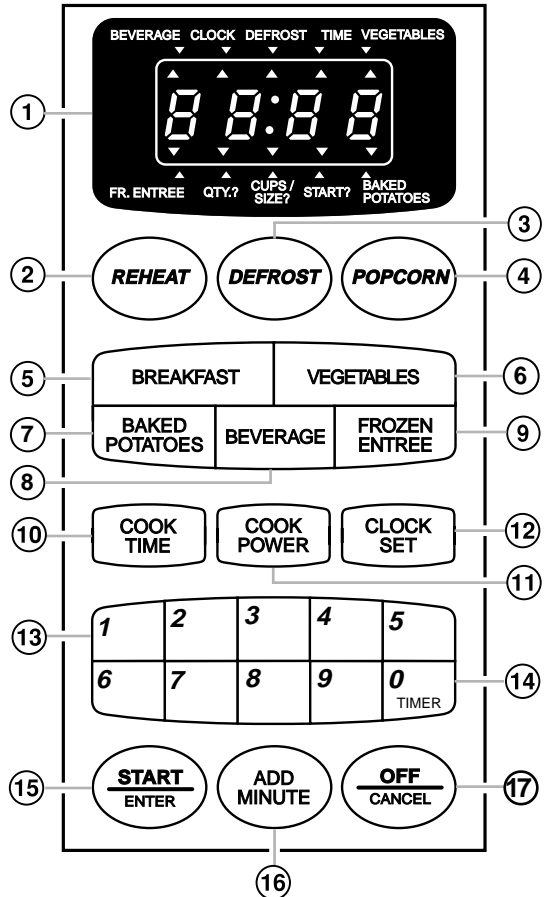

12. **CLOCK SET.** Touch this pad followed by Number pads to enter the correct time of day.
13. **Number Pads.** Touch Number pads to enter cooking times, cook powers, selection quantities or weight.
14. **MINUTE TIMER.** Touch this pad followed by number pads to use as a kitchen timer.
15. **START/ENTER.** Touch this pad to start a function that you have set.
16. **ADD MINUTE.** Touch this pad to cook for one minute at 100% cook power or to add an extra minute to your cooking cycle at the current cook power.
17. **OFF/CANCEL.** Touch this pad to erase an incorrect command or to cancel a program during cooking. This pad will not erase time of day.

## NOTES:

- **If you choose** an auto cook function and change your mind, you must press OFF/CANCEL before you choose another auto cook function.
- **If you attempt** to enter unacceptable instructions, three tones will sound, and “Err” will appear on the display. Touch OFF/CANCEL and re-enter the instructions.
- **Once you choose a function**, an indicator light (▲) will flash as a prompt for the next action you need to perform.
- **If you choose** a function but do not press another command pad within one minute, the display returns to the time of day and you need to start over.
- **If you have entered** all settings for a function but do not touch START/ENTER in 5 seconds, the Start? indicator light will flash.
- **If you open** the door while the oven is on and then shut the door, the Start? indicator light will flash.

## Audible signals

Audible signals are available to guide you when setting and using your oven:

- **A programming tone will sound** each time you touch a pad.
- **Four tones** signal the end of a cooking cycle and two tones will sound every minute until you open the door or press the command pad.
- **Three tones will sound** if you enter incorrect instructions.

## Interrupting cooking

You can stop the oven during a cycle by opening the door. The oven stops heating and the fan stops, but the light stays on.

**To restart cooking, close** the door and

TOUCH



**If you do not want to continue cooking:**

- **Close** the door and the light goes off.

OR

• TOUCH



**NOTE:** Before setting a function, touch OFF/CANCEL to make sure no other function is on.

## Setting the clock

When your microwave oven is first plugged in, or after a power failure, the display will show “:”. If a time of day is not set, “:” will stay on the display until you set the clock or another function.

### NOTES:

- **You can** only set the clock when the oven is not in use.
- **If you enter** an incorrect time, three tones will sound, “Err,” then “0” will appear on the display. Re-enter the correct time.
- **If you touch** OFF/CANCEL while setting the clock, the clock will return to the time already on the display.

### To set time:

#### 1. Choose the setting.

TOUCH



#### 2. Enter the time of day.

Example for 5:30:

TOUCH

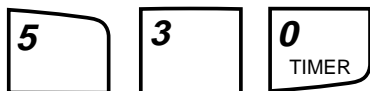

#### 3. Touch CLOCK/SET or START/ENTER.

TOUCH



OR



## Using the minute timer

Your microwave oven can be used as a kitchen timer. Use the minute timer for timing up to 99 minutes, 99 seconds.

#### 1. Touch “0.”

TOUCH

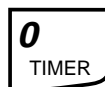

#### 2. Enter the time to be counted down.

TOUCH

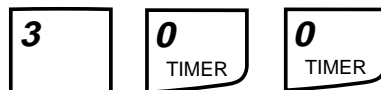

(example: 3 minutes)

#### 3. Start the countdown.

TOUCH



At the end of timer countdown four tones will sound and the display will show “End”.

**NOTE:** The minute timer can be used to set a delayed start time by following Steps 1 and 2 below, then set cook time as described in the “Cooking with more than one cook cycle” section.

# Using Your Microwave Oven

This section gives you instructions for operating each microwave function. Please read these instructions carefully.

## Cooking at high cook power

1. Put the food in the oven and close the door.

2. Set the cooking time.

TOUCH



YOU SEE

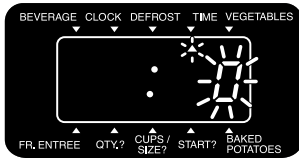

Example for 1 minute, 30 seconds:

TOUCH

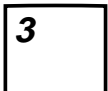
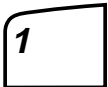

YOU SEE



(Start? indicator light flashes after 5 seconds)

3. Start the oven.

TOUCH



YOU SEE



(cooking time counts down)

4. End of cooking

At end of cooking time:

Four tones will sound and the display will show "End".

YOU SEE



Two tones will sound every minute until you open the door or touch any pad. The display will then return to the time of day.

## Cooking at different cook powers

For best results, some recipes call for different cook powers. The lower the cook power, the slower the cooking. Each Number pad also stands for a different percentage of cook power. Many microwave cookbook recipes tell you by number, percent, or name which cook power to use.

The following chart gives the percentage of cook power each Number pad stands for, and the cook power name usually used. It also tells you when to use each cook power. Follow recipe or food package instructions if available.

**NOTE:** Refer to a reliable cookbook for cooking times.

COOK POWER	NAME	WHEN TO USE IT
10=100% of full power	High	<ul style="list-style-type: none"> <li>• Quick heating many convenience foods and foods with high water content, such as soups and beverages</li> <li>• Cooking small tender pieces of meat, ground meat, poultry pieces, fish fillets, and vegetables</li> </ul>
9=90% of full power		<ul style="list-style-type: none"> <li>• Heating cream soups</li> </ul>
8=80% of full power		<ul style="list-style-type: none"> <li>• Heating rice, pasta, or casseroles</li> </ul>
7=70% of full power	Medium-High	<ul style="list-style-type: none"> <li>• Cooking and heating foods that need a cook power lower than high (for example, whole fish and meat loaf) or when food is cooking too fast</li> <li>• Reheating a single serving of food</li> </ul>
6=60% of full power		<ul style="list-style-type: none"> <li>• Cooking requiring special care, such as cheese and egg dishes, pudding, and custards</li> <li>• Finishing cooking casseroles</li> </ul>
5=50% of full power	Medium	<ul style="list-style-type: none"> <li>• Cooking ham, whole poultry, and pot roasts</li> <li>• Melting chocolate</li> </ul>
4=40% of full power		<ul style="list-style-type: none"> <li>• Simmering stews</li> <li>• Heating pastries</li> </ul>
3=30% of full power	Medium-Low, Defrost	<ul style="list-style-type: none"> <li>• Defrosting foods, such as bread, fish, meats, poultry, and precooked foods</li> </ul>
2=20% of full power		<ul style="list-style-type: none"> <li>• Softening butter, cheese, and ice cream</li> </ul>
1=10% of full power	Low	<ul style="list-style-type: none"> <li>• Keeping food warm</li> <li>• Taking chill out of fruit</li> </ul>

1. Put the food in the oven and close the door.

2. Set the cooking time.

TOUCH



(Example for 7 minutes, 30 seconds:)

TOUCH

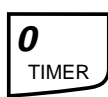
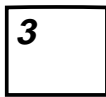

3. Set the cook power.

TOUCH



TOUCH

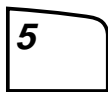

(Example for 50% cook power:)

**NOTES:**

- You cannot enter a cook power higher than 10. If you touch a number from 2 to 9 after you touch Number pad 1, the cook power will become the second number you touched. For example, if you touch Number pads 1 and 4 the cook power would be “4.”

4. Start the oven.

TOUCH



(cooking time counts down)

At end of cooking time:

Four tones will sound and the display will show “End”.

**To see the cook power during cooking:**

**NOTE:** If you wish to change the cook power press the desired Number pad.

TOUCH



(example for 50% cook power)

The power level will be displayed “P-5”.

## Cooking with more than one cook cycle

For best results, some recipes call for one cook power for a certain length of time, and another cook power for another length of time. Your oven can be set to change from one to another automatically, for up to 4 cycles.

**NOTE:** Refer to a reliable cookbook for cooking times and power levels.

1. Put the food in the oven and close the door.

2. Set the cooking time for the first cycle.

TOUCH



Example for 7 minutes, 30 seconds:

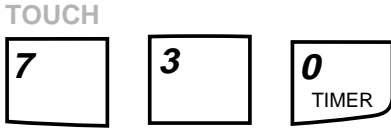

### 3. Set the cook power for the first cycle.



(Example for 50% cook power:)

### 4. Repeat Steps 2 and 3 to set the cooking time and cook power for each additional cycle.

### 5. Start the oven.



The first cycle's cooking time counts down, followed by cooking times for each additional cycle.

At end of cooking time:

Four tones will sound and the display will show "End".

## Changing instructions

You can change the cook power for a cycle only before you start to set the next cycle. To change cook power repeat Step 3. If you want to change the cooking time for a cycle touch OFF/CANCEL and start over.

## Using ADD MINUTE

ADD MINUTE lets you cook food for one minute at 100% cook power or add an extra minute to the current cooking cycle at the current cook power. You can also use it to extend cooking time in multiples of one minute, up to 99 minutes.

### NOTES:

- **To extend** cooking time in multiples of one minute, touch ADD MINUTE repeatedly during cooking.
- **You can use** ADD MINUTE when timed cooking, defrosting, or running any function with preset time.
- **If you touch** ADD MINUTE during cooking, the oven will cook at the currently selected cook power.

### Start cooking:

1. Put the food in the oven and close the door.

2. Touch ADD MINUTE one or more times.

Each press will increase time by one minute.

3. Start the oven.  
Touch **START/ENTER**.

At end of cooking time:

Four tones will sound and the display will show "End".

### During cooking:

Touch **ADD MINUTE** one or more times.

Each press will increase time by one minute at the currently selected cook power.



(example: twice for 2 minutes)

(example for original time of 2:45)



## Using REHEAT

REHEAT lets you reheat one of four different types of food, without needing to set heating times or cook powers. To use REHEAT, follow the steps below:

1. Touch



1-4 times, to select the food setting.

2. Touch one of these Number pads to enter the quantity.

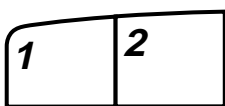

3. Touch



### NOTES:

- **For casserole, soups/sauces, and pizza slice**, if you do not enter a quantity within 2 seconds, REHEAT will prompt you to choose a quantity. You have 1 minute to either enter a quantity and touch START/ENTER or accept the minimum quantity displayed by pressing START/ENTER. If you do not touch any pad within 1 minute, REHEAT will be canceled.

- **If you touch** a Number pad higher than the maximum allowed for your food setting, three tones will sound, and the display will show “Err” for 1 second, followed by a prompt telling you which quantities you can choose from.

- **If you touch** START/ENTER before entering a quantity, your oven will automatically be set to reheat the minimum quantity.

- **If you touch** REHEAT 5 times, the display goes back to the Dinner Plate setting.

## Reheating tips

- **Cooked food and leftovers** can be reheated quickly and efficiently without spoiling their freshness and taste.

- **Always place** the dense food at the outer edges and the more porous food towards the center.

- **To keep food moist** during reheating, cover the food with a microwave-safe lid, plastic wrap or wax paper. Covering the food keeps heat in the food, speeds heating, and prevents spatters.

- **Wrap sandwiches and rolls** loosely in paper towels to absorb moisture and prevent sogginess.

- **Spread food** in a shallow dish if possible.

- **Stir and turn** food as needed.

- **Always underestimate** reheating time until you are used to the microwave oven.

This chart shows you which foods you can reheat and how to program your oven to reheat them. All foods are reheated from refrigerated temperature.

FOOD	TOUCH REHEAT	DISPLAY SHOWS	QUANTITIES AVAILABLE
Dinner Plate	1 time	dinr	1 plate
Casserole	2 times	CASS	1-2 cups (250mL-500mL)
Soups/ Sauces	3 times	SOUP	1-2 cups (250mL-500mL)
Pizza Slice	4 times	PIZZ	1-2 slices

## Using DEFROST

Your microwave oven lets you defrost food by simply entering defrosting time. A 30% cook power is preset.

**NOTE:** Refer to a reliable cookbook for defrosting times.

### 1. Put the frozen food in the oven and close the door.

### 2. Touch DEFROST.

**NOTE:** You can use defrost instead of a cook cycle when cooking with more than one cycle.

TOUCH



### 3. Enter the defrosting time.

TOUCH

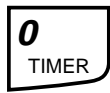
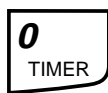
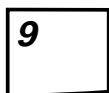

### 4. Start the oven.

TOUCH



(defrosting time counts down)

At end of defrosting time:

Four tones will sound and the display will show "End".

## Defrosting tips

- **Before starting**, make sure you have removed any metal twist-ties and replace them with strings or elastic bands.
- **Open containers** before they are placed in the oven.
- **Always slit** or pierce plastic pouches or packaging.
- **If food is foil wrapped**, remove foil and place it in a microwave safe container.
- **Slit** the skins, if any, of frozen food such as sausage or hot dogs.
- **Bend** plastic pouches of food to ensure even defrosting.
- **Always underestimate** defrosting time. If defrosted food is still icy in the center, return it to the microwave oven for more defrosting.
- **The length** of defrosting time varies according to how solidly the food is frozen.
- **The shape of the package** alters the defrosting time. Shallow, rectangular packets defrost more quickly than a deep block.
- **Separate pieces** as they begin to defrost. Separated pieces defrost more easily.
- **You can use small pieces** of aluminum foil to shield foods like chicken wings, leg tips, and fish tails, but the foil must not touch the side of the oven. Foil can damage the oven lining.
- **Shield areas of food** with small pieces of foil if the food begins to get warm. Make sure the foil does not touch the sides, top, or bottom of the oven.
- **For better results**, let food stand after defrosting. (For more information on standing time, see "Microwave cooking tips" in the "Cooking Guide" section.)
- **Turn food over** during defrosting or standing time. Break apart and remove food when required.

## Using POPCORN

POPCORN lets you pop a “snack size” bag (1.75 oz [50g]) of commercially packaged microwave popcorn by touching just 2 pads.

### For best results:

- **Pop** only one package at a time.
- **If you are using** a microwave popcorn popper, follow the manufacturer’s instructions.
- **Cooking performance** may vary with brand and fat content. Try several brands to decide which gives best popping results.
- **Use** fresh bags of popcorn.

**NOTE:** Do not use popcorn bags that are larger than the “snack size” bags recommended above. As a larger bag expands, it may interfere with the rotation of the turntable, causing it to slow down or stop.

**1. Place the bag in the center of the turntable and close the door.**

**2. Touch**



**3. Start the oven.**

TOUCH



(popping time counts down)

At end of heating time:

Four tones will sound, and the display shows “End”.

## Using BREAKFAST

BREAKFAST lets you heat one of three types of breakfast foods, without needing to set heating times or cook powers. To use BREAKFAST, follow the steps below:

**1. Touch**  **1-3 times, to select the food setting.**

**2. Touch one of these Number pads to enter the quantity.**

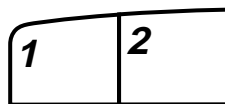

**3. Touch**



### NOTES:

- **If you do not enter** a quantity within 2 seconds, BREAKFAST will prompt you to choose a quantity. You have 1 minute to either enter a quantity and press START/ENTER or accept the minimum quantity displayed by pressing START/ENTER.
- **If you touch** a Number pad higher than the maximum allowed for your food setting, three tones will sound, and the display will show “Err” for 1 second, followed by a prompt telling you which quantities you can choose from.
- **If you touch** START/ENTER before entering a quantity, your oven will automatically be set to heat the minimum quantity.
- **If you touch** BREAKFAST 4 times, the display goes back to the French Toast/Waffles setting.

## USING YOUR MICROWAVE OVEN

This chart shows you which foods you can heat and how to program your oven to heat them.

FOOD	TOUCH BREAKFAST	DISPLAY SHOWS	QUANTITIES AVAILABLE
French Toast/Waffles (Fresh)	1 time	P1	1-2 pieces
Bagels/Muffins (Fresh)	2 times	P2	1-2 pieces
Hot Cereals (Instant)	3 times	P3	1-2 servings

### Using VEGETABLES

VEGETABLES lets you heat one of two types of vegetables, without needing to set heating times or cook powers. To use VEGETABLES, follow the steps below:

1. Touch  1-2 times, to select the vegetable setting.

2. Touch one of these Number pads to enter the quantity.

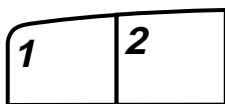

3. Touch



#### NOTES:

- **If you do not enter** a quantity within 2 seconds, VEGETABLES will prompt you to choose a quantity. You have 1 min. to either
  - Enter a quantity and press START/ENTER or
  - Accept minimum quantity displayed by pressing START/ENTER.
 If you do not touch any pad within 1 minute, VEGETABLES will be canceled.
- **If you touch** a Number pad higher than the maximum allowed for your vegetable setting, three tones will sound, and the display will show “Err” for 1 second, followed by a prompt telling you which quantities you can choose from.
- **If you touch** START/ENTER before entering a quantity, your oven will automatically be set to heat a quantity of “1.”
- **If you touch** VEGETABLES 3 times, the display goes back to the Frozen Vegetables setting.

This chart shows you which types of vegetables you can heat and how to program your oven to heat them.

FOOD	TOUCH VEGETABLES	DISPLAY SHOWS	QUANTITIES AVAILABLE
Frozen Vegetables	1 time	P1	1-2 cups (250mL-500mL)
Fresh Vegetables	2 times	P2	1-2 cups (250mL-500mL)

## Using BAKED POTATOES

Your microwave oven cooks 1 to 2 baking potatoes (10-13 oz [284-396] each) by automatically choosing baking time and cook power. Before baking, remember to pierce potato with a fork several times. After cooking, let potato stand 5 minutes wrapped in foil.

**NOTE:** If more time is needed do not touch BAKED POTATOES again. Use ADD MINUTE. (See "Using ADD MINUTE" earlier in this section.)

**1. Put pierced potatoes on a paper towel in the oven and close the door.**

**2. Touch BAKED POTATOES.**

TOUCH



**3. Enter the number of potatoes.**

TOUCH



(example for 2 potatoes)

**4. Start the oven.**

TOUCH



(cooking time counts down)

At end of cooking time:

Four tones will sound and the display will show "End".

### NOTES:

- **If you do not enter** a number after touching BAKED POTATOES you will see "1" with the Qty.? and Baked Potatoes indicator lights on and the Start? indicator light flashing. You can touch START/ENTER to bake one potato or enter "2" to bake more. If you do not touch any pad, the Baked Potatoes function will cancel out.
- **If you touch** a Number pad above 2, you will hear three tones and see "Err" on the display for one second, followed by "1-2" with the Qty.? and Baked Potatoes indicator lights on.
- **If you touch** START/ENTER before entering the number of servings, the oven will automatically be set to bake one potato.

## Using BEVERAGE

BEVERAGE lets you heat an 8 to 10 ounce (240mL to 300mL) beverage by touching just 2 pads.

**1. Place a cup of a beverage in the oven and close the door.**

**2. Touch**



**3. Start the oven.**

TOUCH



(heating time counts down)

At end of heating time:

Four tones will sound and the display will show "End".

## Using FROZEN ENTREE

FROZEN ENTREE lets you cook a frozen entree between 10 and 12 oz (285g and 340g) by touching just 2 pads.

### NOTES:

- **If more time is needed** do not touch FROZEN ENTREE again. Use ADD MINUTE. (See “Using ADD MINUTE” in the “Getting to Know” section.)
- **Follow** manufacturer's guidelines for preparation of the frozen entree.

### 1. Place the frozen entree on the turntable and close the door.

### 2. Touch



### 3. Start the oven.

TOUCH



The preset cook time for frozen entrees will begin to count down.

At end of cooking time:

Four tones will sound and the display will show “End”.

# Caring for Your Microwave Oven

To make sure your microwave oven looks good and works well for a long time, you should maintain it properly. For proper care, please follow these instructions carefully.

**For interior surfaces:** Wash often with warm, sudsy water and a sponge or soft cloth. **Use** only mild, nonabrasive soaps or a mild detergent. **Be sure to keep the areas clean where the door and oven frame touch when closed. Wipe** well with clean water. Over time, stains can occur on the surfaces as the result of food particles splattering during cooking. This is normal.

For stubborn soil, **boil** a cup of water in the oven for 2 or 3 minutes. Steam will soften the soil. To get rid of odors inside the oven, **boil** a cup of water with lemon juice or vinegar.

**For exterior surfaces and control panel:** Use a soft cloth with spray glass cleaner. Apply the spray glass cleaner to the soft cloth; do not spray directly on the oven.

**NOTE: Abrasive cleansers, steel-wool pads, gritty wash cloths, some paper towels, etc.,** can damage the control panel and the interior and exterior oven surfaces.

**To clean turntable and turntable support,** wash in mild, sudsy water; for heavily soiled areas **use** a mild cleanser and scouring sponge. The turntable and turntable support are dishwasher-safe.

# Cooking Guide

## Microwave cooking tips

### Amount of food

- **If you increase or decrease** the amount of food you prepare, the time it takes to cook that food will also change. For example, if you double a recipe, add a little more than half the original cooking time. Check for doneness and, if necessary, add more time in small increments.

### Starting temperature of food

- **The lower the temperature** of the food being put into the microwave oven, the longer it takes to cook. Food at room temperature will be reheated more quickly than food at refrigerator temperature.

### Composition of food

- **Food with a lot of fat and sugar** will be heated faster than food containing a lot of water. Fat and sugar will also reach a higher temperature than water in the cooking process.
- **The more dense the food**, the longer it takes to heat. “Very dense” food like meat takes longer to reheat than lighter, more porous food like sponge cakes.

### Size and shape

- **Smaller pieces of food** will cook faster than larger pieces and same-shaped pieces of food cook more evenly than irregularly shaped foods.
- **With unevenly shaped foods**, the thinner parts will cook faster than the thicker areas. **Place** the thinner parts of chicken wings and legs in the center of the dish.

### Stirring, turning foods

- **Stirring and turning foods** distributes heat quickly to the center of the dish and avoids overcooking at the outer edges of the food.

### Covering food

#### Cover food to:

- **Reduce** splattering
- **Shorten** cooking times
- **Retain** food moisture

All coverings that allow microwaves to pass through are suitable.

### Releasing pressure in foods

- **Several foods** (for example: baked potatoes, sausages, egg yolks, and some fruits) are tightly covered by a skin or membrane. This can cause the food to burst from steam building up in them during cooking. To relieve the pressure and to prevent bursting, **pierce** these foods before cooking with a fork, cocktail pick, or toothpick.

### Using standing time

- **Always allow food to stand** for a while after cooking. Standing time after defrosting, cooking, or reheating always improves the result since the temperature will then be evenly distributed throughout the food.
- **The length of the standing time** depends on the volume and density of the food. Sometimes it can be as short as the time it takes you to remove the food from the oven and take it to the serving table. However, with larger, denser food, the standing time may be as long as 10 minutes.

### Arranging food

For best results, distribute food evenly on the plate. You can do this in several ways:

- **If you are cooking several items of the same food**, such as baked potatoes, **place** them in a ring pattern for uniform cooking.
- **When cooking foods of uneven shapes or thickness, such as chicken breasts**, **place** the smaller or thinner area of the food towards the center of the dish where it will be heated last.
- **Layer thin slices of meat** on top of each other.
- **When you cook or reheat whole fish**, **score** the skin – this prevents cracking. Shield the tail and head of whole fish with small pieces of foil to prevent overcooking but ensure the foil does not touch the sides of the oven.
- **Do not** let food or a container touch the top or sides of the oven. This will prevent possible arcing.

### Using aluminum foil

Metal containers should not be used in a microwave oven. There are, however, some exceptions. If you have purchased food which is prepackaged in an aluminum foil container, then refer to the instructions on the package. When using aluminum foil containers, cooking times may be longer because microwaves will only penetrate the top of the food.

If you use aluminum containers without package instructions, follow these guidelines:

- **Place** container in a glass bowl and add some water so that it covers the bottom of the container, not more than  $\frac{1}{4}$  inch (6mm) high. This ensures even heating of the container bottom.

- **Always remove** the lid to avoid damage to the oven.
- **Use only** undamaged containers.
- **Do not use** containers taller than  $\frac{3}{4}$  inch (19mm).
- **Container must be** half filled.
- **To avoid arcing**, there must be a minimum  $\frac{1}{4}$  inch (6mm) between the aluminum container and the walls of the oven and also between two aluminum containers.
- **Always place** container on turntable.
- **Reheating food** in aluminum foil containers usually takes up to double the time compared to reheating in plastic, glass, china, or paper containers. The time when food is ready will vary depending upon the type of container you use.
- **Let food stand** for 2-3 minutes after heating so that heat is spread evenly throughout container.

### Cooking you should not do in your microwave oven

- **Do not** do canning of foods in the oven. Closed glass jars may explode, resulting in damage to the oven or possible personal injury.
- **Do not** use the microwave oven to sterilize objects (baby bottles, etc.). It is difficult to maintain the high temperature required for safe sterilization.



# Questions and Answers

QUESTIONS	ANSWERS
Can I operate my microwave oven without the turntable or turn the turntable over to accommodate a large dish?	No. If you remove or turn over the turntable, you will get poor cooking results. Dishes used in your oven must fit on the turntable.
Can I use a rack in my microwave oven so that I may reheat or cook on two levels at a time?	You can use a rack only if rack is supplied with your microwave oven. Use of any rack not supplied with the microwave oven can result in poor cooking performance and/or arcing.
Can I use either metal or aluminum pans in my microwave oven?	Useable metal includes aluminum foil for shielding (use small, flat pieces), small skewers, and shallow foil trays (if tray is $\frac{3}{4}$ inch [19mm] deep and half filled with food to absorb microwave energy). Never allow metal to touch walls or door. (For more information, see "Using aluminum foil" in the "Cooking Guide" section.)
Is it normal for the turntable to turn in either direction?	Yes. The turntable rotates clockwise or counterclockwise, depending on the rotation of the motor when the cooking cycle begins.
Sometimes the door of my microwave oven appears wavy. Is this normal?	This appearance is normal and does not affect the operation of your oven.
What are the humming noises that I hear when my microwave oven is operating?	You hear the sound of the transformer when the magnetron tube cycles on.
Why does the dish become hot when I microwave food in it? I thought that this should not happen.	As the food becomes hot it will conduct the heat to the dish. Be prepared to use hot pads to remove food after cooking.
What does "standing time" mean?	"Standing time" means that food should be removed from the oven and covered for additional time to allow it to finish cooking. This frees the oven for other cooking.
Can I pop popcorn in my microwave oven? How do I get the best results?	Yes. Pop packaged microwave popcorn following manufacturer's guidelines or use the preprogrammed Popcorn pad. Do not use regular paper bags. Use the "listening test" by stopping the oven as soon as the popping slows to a "pop" every one or two seconds. Do not repop unpopped kernels. Do not pop popcorn in glass utensils.
Why does steam come out of the air exhaust vent?	Steam is normally produced during cooking. The microwave oven has been designed to vent this steam out the rear vents.

# Troubleshooting

Most cooking problems often are caused by little things you can find and fix without tools of any kind. Check the lists below and on the next page before calling for assistance or service. If you still need help, see the “Requesting Assistance or Service” section.

## If microwave does not operate, first check the following:

- Is the microwave oven plugged into a live outlet with the proper voltage? (See Installation Instructions.)
- Have you blown a household fuse or tripped a circuit breaker?
- Has the electric company experienced a power failure?

## Other possible problems and their causes:

PROBLEM	CAUSE
<b>The microwave oven will not run</b>	<ul style="list-style-type: none"><li>• The door is not firmly closed and latched.</li><li>• You did not touch START/ENTER.</li><li>• You did not follow directions exactly.</li><li>• An operation that was programmed earlier is still running.</li><li>• You have not entered numbers after touching COOK TIME.</li></ul>
<b>Microwave cooking times seem too long</b>	<ul style="list-style-type: none"><li>• The electric supply to your home or wall outlets is low or lower than normal. Your electric company can tell you if the line voltage is low. Your electrician or service technician can tell you if the outlet voltage is low.</li><li>• The cook power is not at the recommended setting.</li><li>• Larger amounts of food need longer cooking times.</li></ul>
<b>The turntable will not turn</b>	<ul style="list-style-type: none"><li>• The turntable is not correctly in place. Make sure the turntable is correct-side up and is sitting securely on center shaft.</li><li>• The support is not operating correctly. Remove turntable, check that the turn table support is properly in place and restart oven. If turntable support does not move, call an authorized service technician for repair. Cooking without the turntable can give you poor results.</li></ul>
<b>The display shows a time counting down but the oven is not cooking</b>	<ul style="list-style-type: none"><li>• The oven door is not closed completely.</li><li>• You have set the controls as a kitchen timer. Touch OFF/CANCEL to cancel the Minute Timer.</li></ul>
<b>You do not hear the Programming Tone</b>	<ul style="list-style-type: none"><li>• The command is not correct.</li></ul>
<b>The fan seems to be running slower than usual</b>	<ul style="list-style-type: none"><li>• The oven has been stored in a cold area. The fan will run slower until the oven warms up to normal room temperature.</li></ul>
<b>The display shows “:”</b>	<ul style="list-style-type: none"><li>• There has been a power interruption. Reset the clock.</li></ul>

If none of these items was causing your problem, see the “Requesting Assistance or Service” section.

# Requesting Assistance or Service

Before calling for assistance or service, please check the “Troubleshooting” section. It may save you the cost of a service call. If you still need help, follow the instructions below.

## 1. If you need assistance\* ...

Call our toll free number. Dial toll free from anywhere in the U.S.A.:



**1-800-253-1301**

and talk with one of our trained consultants. The consultant can instruct you in

how to obtain satisfactory operation from your appliance or, if service is necessary, recommend a qualified service company in your area.

## 2. If you need service\* ...

Contact the dealer from whom you purchased the appliance or the authorized servicer in your area. For help finding an authorized servicer in your area, call our toll free telephone number in Step 1.



## 3. If you need replacement parts ...

To locate replacement parts in your area, refer to Step 2 or call our Consumer Assistance Center number in Step 1.

### \* When asking for help or service:

Please provide a detailed description of the problem, your appliance's complete model and serial numbers, and the purchase date. (See the “A Note to You” section.) This information will help us respond properly to your request.

# CROSLEY®

## Microwave Oven Warranty

LENGTH OF WARRANTY	CROSLEY WILL PAY FOR
<b>FULL ONE-YEAR WARRANTY</b> FROM DATE OF PURCHASE	Replacement parts and repair labor to correct defects in materials or workmanship. Service must be provided by an authorized service company.
<b>LIMITED FOUR-YEAR WARRANTY</b> SECOND THROUGH FIFTH YEAR FROM DATE OF PURCHASE	Replacement magnetron tube on microwave ovens if defective in materials or workmanship.
CROSLEY WILL NOT PAY FOR	
<p><b>A.</b> Service calls to:</p> <ol style="list-style-type: none"> <li>1. Correct the installation of your microwave oven.</li> <li>2. Instruct you how to use your microwave oven.</li> <li>3. Replace house fuses or correct house wiring.</li> <li>4. Replace owner-accessible light bulbs.</li> </ol> <p><b>B.</b> Repairs when your microwave oven is used in other than normal, single-family household use.</p> <p><b>C.</b> In-home service. Your microwave oven must be taken to an authorized service company.</p> <p><b>D.</b> Damage to your microwave oven caused by accident, misuse, fire, flood, acts of God, or use of products not approved by Crosley.</p> <p><b>E.</b> Any labor costs during limited warranty.</p> <p><b>F.</b> Repairs to parts or systems caused by unauthorized modifications made to the appliance.</p>	

3/98

**CROSLEY SHALL NOT BE LIABLE FOR INCIDENTAL OR CONSEQUENTIAL DAMAGES.** Some states do not allow the exclusion or limitation of incidental or consequential damages, so this exclusion or limitation may not apply to you. This warranty gives you specific legal rights, and you may also have other rights which vary from state to state.

**Outside the United States, a different warranty may apply. For details, please contact your authorized Crosley dealer.**

If you need assistance or service, first see the "Troubleshooting" section of this book. After checking "Troubleshooting," additional help can be found by checking the "Requesting Assistance or Service" section. Call our Consumer Assistance Center at **1-800-253-1301**.